

## Product data sheet



### Information

Designation	Quarter-circle curtain rail, 900 x 900 mm, Chrome and nickel-plated Brass, tube Ø 16 mm
Reference	004434

### Product advantages

- + Corrosion resistant warranty.

### Description

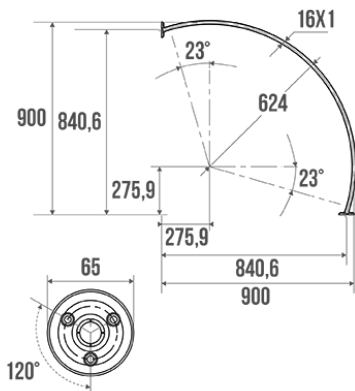

Tube Ø 16 x 1 mm.  
Minimum curtain width : 1400 mm 1800 mm.  
Cannot be shortened.  
2 welded flanges.

Wall fixings not included.

### Technical characteristics

Material	Brass
Finish	Chrome and nickel-plated
Dimensions	900 x 900 mm
Diameter Ø	16 mm
Gross weight	0.660 kg
Packaging	Plastic protection bag
Guarantee	10 years
Gencod	3563390044346
Custom code	7418200090
Technical sheet	No technical sheet available

### Fixing and maintenance advices



Careful consideration and selection of the appropriate wall fixings according to the wall-mounted support is required to ensure the long life of your accessory. The use of stainless steel screws ( $\varnothing$  4 mm) is highly recommended to prevent corrosion in damp environment. Before drilling, physically hold the product against the wall at desired position and mark the hole locations. All the fixing points must be respected. After installation and before use, make sure that all fixing screws are tightened securely.

## Maintenance

**IMPORTANT:** To ensure the sustainability of the product and user safety, we recommend using a solution made of mild soap for cleaning. **CAUTION: DO NOT USE** cleaning products made of: etones, hydrocarbons, acids, bases, esters and ethers. After use of a cleaning product, make a rinsing in the clear water.

Fiche produit mise à jour le : 11/01/2019